

Specifications	ECN 1324S – Singleturn	EQN 1336S – Multiturn
Part number	1179144-01	1179145-01
Functional safety For applications up to	As single-encoder system for monitoring and closed-loop functions <ul style="list-style-type: none"> • SIL 2 according to EN 61 508 (further basis for testing: EN 61 800-5-2) • Category 3, PL d according to EN ISO 13849-1:2015 Safe in the singleturn range	
PFH ¹⁾	$\leq 27 \cdot 10^{-9}$ (Probability of dangerous Failure per Hour)	
Safe position ²⁾	<i>Encoder:</i> $\pm 1.76^\circ$ (safety-related measuring step: SM = 0.7°) <i>Mechanical coupling:</i> $\pm 2^\circ$ fault exclusion for loosening of shaft and stator coupling, designed for accelerations of $\leq 300 \text{ m/s}^2$	
Interface/ordering designation	DRIVE-CLiQ / DQ01	
Firmware	01.32.26.53	
Siemens software (version 12.2.2014)	SINAMICS, SIMOTION: \geq V4.4 HF4; SINUMERIK with safety: \geq V4.4 SP2; SINUMERIK without safety: \geq V4.4 SP1 HF3	
Position values/revolution	16777216 (24 bits)	
Revolutions	–	4096 (12 bits)
Processing time TIME_MAX_ACTVAL	$\leq 8 \mu\text{s}$	
System accuracy	$\pm 20''$	
Electrical connection	Encoder PCB connector: 16-pin; with connection for temperature sensor ³⁾	
Cable length	< 40 m (for the calculation see the brochure <i>Cables and Connectors</i>)	
Voltage supply	DC 24 V (10 V to 28.8 V); up to DC 36.0 V possible without compromising functional safety	
Power consumption ⁴⁾ (maximum)	At 10 V: $\leq 900 \text{ mW}$; at 28.8 V: $\leq 1000 \text{ mW}$	At 10 V: $\leq 1000 \text{ mW}$; at 28.8 V: $\leq 1140 \text{ mW}$
Current consumption (typical)	At 24 V: 38 mA (without load)	At 24 V: 43 mA (without load)
Shaft	Taper shaft $\varnothing 9.25 \text{ mm}$; taper 1:10	
Speed	$\leq 15000 \text{ rpm}$ (with ≥ 2 position requests/rev)	$\leq 12000 \text{ rpm}$ (with ≥ 2 position requests/rev)
Starting torque (at 20 °C)	$\leq 0.01 \text{ Nm}$	
Moment of inertia of rotor	$2.6 \cdot 10^{-6} \text{ kgm}^2$	
Angular acceleration of rotor	$\leq 1 \cdot 10^5 \text{ rad/s}^2$	
Axial motion of measured shaft	$\leq \pm 0.5 \text{ mm}$	
Vibration 55 Hz to 2000 Hz Shock 6 ms	$\leq 300 \text{ m/s}^2$ (EN 60068-2-6); 10 Hz to 55 Hz constant over 4.9 mm peak to peak $\leq 2000 \text{ m/s}^2$ (EN 60068-2-27)	
Operating temperature	–30 °C to 100 °C	
Trigger threshold of error message for excessive temperature	117 °C in the scanning ASIC (measuring accuracy of internal temperature sensor: $\pm 2 \text{ K}$ at 117 °C)	
Relative humidity	$\leq 93 \%$ (40 °C/21 d as per EN 60068-2-78); without condensation	
Protection EN 60529	IP40 (see <i>Insulation</i> under <i>Electrical safety</i> in the brochure <i>Interfaces of HEIDENHAIN Encoders</i> ; Contamination by penetrating liquids must be avoided)	
Mass	$\approx 0.25 \text{ kg}$	

¹⁾ For altitude of $\leq 1000 \text{ m}$ above sea level

²⁾ Further tolerances may occur in subsequent electronics after position value comparison (contact manufacturer of subsequent electronics)

³⁾ See *Temperature measurement in motors* in the brochure *Encoders for Servo Drives*

⁴⁾ See *General electrical information* in the brochure *Interfaces of HEIDENHAIN Encoders*

ECN 1324S, EQN 1336S

Rotary encoders for absolute position values with safe singleturn information

- Installation diameter 65 mm
- Expanding ring coupling 07B
- Blind hollow shaft for axial clamping 67M

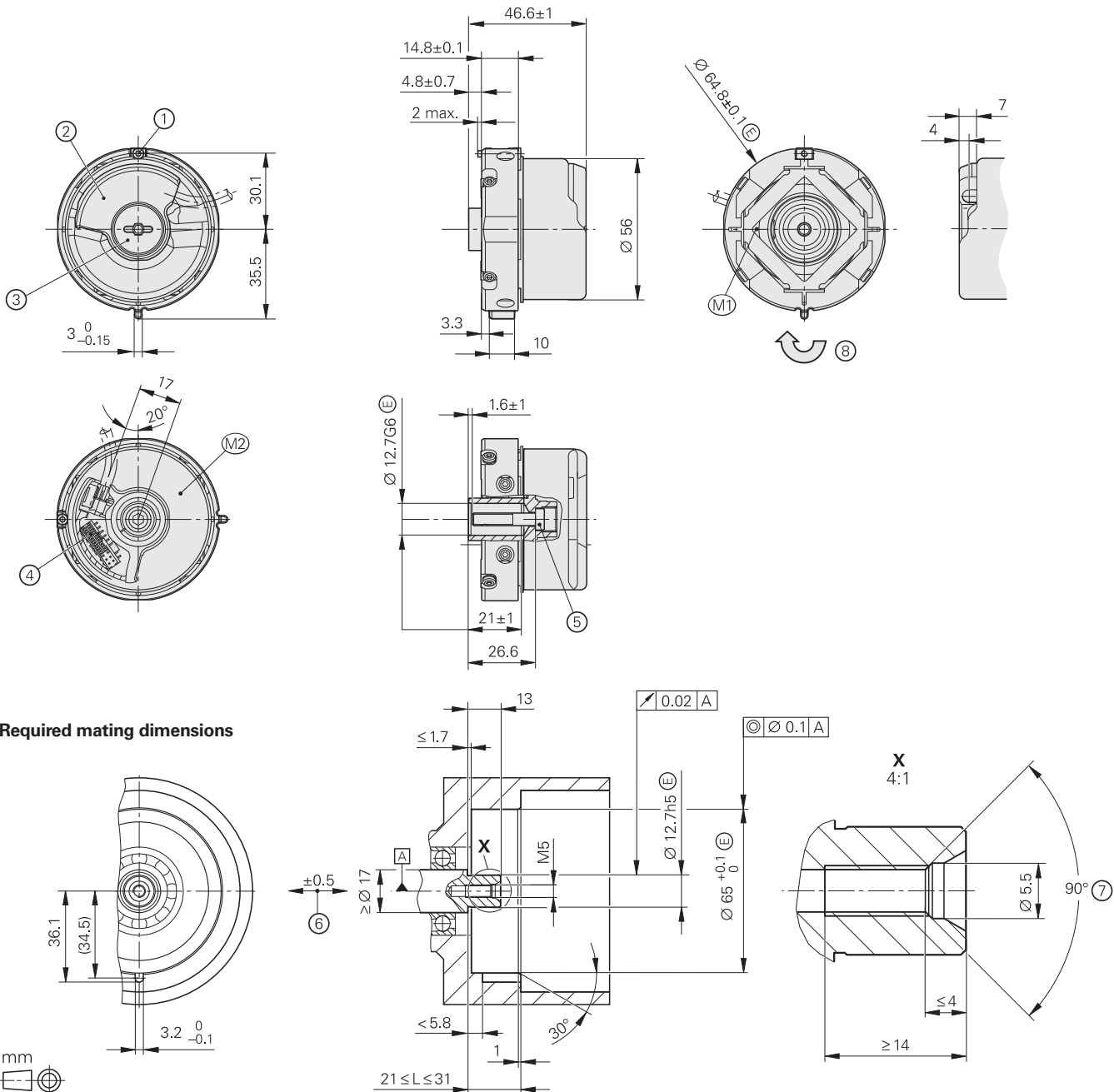

Required mating dimensions

mm

 Tolerancing ISO 8015
 ISO 2768 - m H
 <math>< 6 \text{ mm}</math>: $\pm 0.2 \text{ mm}$

- ☐ = Bearing of mating shaft
- M1 = Measuring point for operating temperature
- M2 = Measuring point for vibration, see D741714
- 1 = Clamping screw for coupling ring width A/F 2, tightening torque 1.25–0.2 Nm
- 2 = Die-cast cover
- 3 = Screw plug width A/F 3 and A/F 4, tightening torque 5+0.5 Nm
- 4 = 16-pin header
- 5 = Screw DIN 6912 – M5x25 – 08.8 – MKL width A/F 4, tightening torque 5+0.5 Nm
- 6 = Compensation of mounting tolerances and thermal expansion, no dynamic movement permitted
- 7 = Chamfer is obligatory at start of thread for materially bonding anti-rotation lock
- 8 = Direction of shaft rotation for output signals as per the interface description

Specifications	ECN 1324S – Singleturn	EQN 1336S – Multiturn
ID number	1179144-03 ⁵⁾	1179145-02 ⁵⁾
Functional safety For applications up to	As single-encoder system for monitoring and closed-loop functions <ul style="list-style-type: none"> • SIL 2 according to EN 61 508 (further basis for testing: EN 61 800-5-2) • Category 3, PL d according to EN ISO 13849-1:2015 Safe in the singleturn range	
PFH ¹⁾	$\leq 27 \cdot 10^{-9}$ (Probability of dangerous Failure per Hour)	
Safe position ²⁾	<i>Encoder</i> : $\pm 1.76^\circ$ (safety-related measuring step: SM = 0.7°) <i>Mechanical coupling</i> : $\pm 2^\circ$ fault exclusion for loosening of shaft and stator coupling, designed for accelerations of $\leq 300 \text{ m/s}^2$)	
Interface/ordering designation	DRIVE-CLiQ / DQ01	
Firmware	01.32.26.53	
Siemens software (version 12.2.2014)	SINAMICS, SIMOTION: $\geq \text{V4.4 HF4}$; SINUMERIK with safety: $\geq \text{V4.4 SP2}$; SINUMERIK without safety: $\geq \text{V4.4 SP1 HF3}$	
Position values/revolution	16777216 (24 bits)	
Revolutions	–	4096 (12 bits)
Processing time TIME_MAX_ACTVAL	$\leq 8 \mu\text{s}$	
System accuracy	$\pm 20''$	
Electrical connection	Encoder PCB connector: 16-pin; with connection for temperature sensor ³⁾	
Cable length	< 40 m (for the calculation see the brochure <i>Cables and Connectors</i>)	
Voltage supply	DC 24 V (10 V to 28.8 V); up to DC 36.0 V possible without compromising functional safety	
Power consumption ⁴⁾ (maximum)	At 10 V: $\leq 900 \text{ mW}$; at 28.8 V: $\leq 1000 \text{ mW}$	At 10 V: $\leq 1000 \text{ mW}$; at 28.8 V: $\leq 1140 \text{ mW}$
Current consumption (typical)	At 24 V: 38 mA (without load)	At 24 V: 43 mA (without load)
Shaft	Blind hollow shaft for axial clamping $\varnothing 12.7 \text{ mm}$	
Speed	$\leq 12000 \text{ rpm}$ (with ≥ 2 position requests/rev)	
Starting torque (at 20 °C)	$\leq 0.01 \text{ Nm}$	
Moment of inertia of rotor	$3.4 \cdot 10^{-6} \text{ kgm}^2$	
Angular acceleration of rotor	$\leq 5 \cdot 10^4 \text{ rad/s}^2$	
Axial motion of measured shaft	$\leq \pm 0.5 \text{ mm}$	
Vibration 55 Hz to 2000 Hz ⁵⁾ Shock 6 ms	$\leq 300 \text{ m/s}^2$ (EN 60068-2-6); 10 Hz to 55 Hz constant over 4.9 mm peak to peak $\leq 2000 \text{ m/s}^2$ (EN 60068-2-27)	
Operating temperature	–30 °C to 100 °C	
Trigger threshold of error message for excessive temperature	117 °C in the scanning ASIC (measuring accuracy of internal temperature sensor: $\pm 2 \text{ K}$ at 117 °C)	
Relative humidity	$\leq 93 \%$ (40 °C/21 d as per EN 60068-2-78); without condensation	
Protection EN 60529	IP40 (see <i>Insulation</i> under <i>Electrical safety</i> in the brochure <i>Interfaces of HEIDENHAIN Encoders</i> ; Contamination by penetrating liquids must be avoided)	
Mass	$\approx 0.25 \text{ kg}$	

¹⁾ For altitude of $\leq 1000 \text{ m}$ above sea level

²⁾ Further tolerances may occur in subsequent electronics after position value comparison (contact manufacturer of subsequent electronics)

³⁾ See *Temperature measurement in motors* in the brochure *Encoders for Servo Drives*

⁴⁾ See *General electrical information* in the brochure *Interfaces of HEIDENHAIN Encoders*

⁵⁾ Upon request

Mounting

The shaft of the rotary encoder is slid onto the motor's drive shaft and fastened with a central screw. It is particularly important to ensure that the positive-locking element of the stator coupling securely engages the corresponding slot in the mating part. Use a central screw with material-bonding anti-rotation lock (see *Mounting accessories*). The stator coupling is clamped by an axially tightened screw in a location bore.

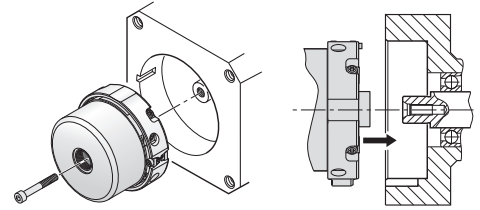

Conditions required on the motor side for a safe mechanical connection:

	Mating shaft	Mating stator
Material	Steel	Aluminum
Tensile strength R_m	$\geq 600 \text{ N/mm}^2$	$\geq 220 \text{ N/mm}^2$
Interface pressure P_G	$\geq 500 \text{ N/mm}^2$	$\geq 200 \text{ N/mm}^2$
Surface roughness R_z	$\leq 16 \mu\text{m}$	
Coefficient of thermal expansion α_{therm}	$(10 \text{ to } 17) \cdot 10^{-6} \text{ K}^{-1}$	$\leq 25 \cdot 10^{-6} \text{ K}^{-1}$

The following maximum torque M_{max} has to be considered when designing the mechanical fault exclusion for the shaft connection:

$$M_{\text{max}} = 1.0 \text{ Nm}$$

Mounting accessories

Screws

Screws (central screw, mounting screws) are not included in delivery. They can be ordered separately.

ECN 1324S, EQN 1336S	Central screws for fastening the shaft ¹⁾		Lot size
For tapered shaft 65B	DIN 6912-M5x50-08.8-MKL	ID 202264-54	10 or 100 pieces
For hollow shaft 67M	DIN 6912-M5x25-08.8-MKL	ID 202264-55	

¹⁾ With coating for material bonding anti-rotation lock

Please note the information on screws from HEIDENHAIN in the catalog titled *Encoders for Servo Drives*, chapter *General mechanical information* under *Rotary encoders with functional safety*.

Mounting aid

The mounting aid serves to plug and unplug the PCB connector. It prevents damage to the cable because the strain is applied only to the connector. The wires must not be pulled.

ID 1075573-01



For further mounting information and mounting aids, refer to the *Encoders for Servo Drives* catalog.

Integrated temperature evaluation

These rotary encoders feature an internal temperature sensor integrated in the encoder electronics as well as an evaluation circuit for an external temperature sensor. In both cases, the respective digitized temperature value is transmitted purely serially via the DRIVE-CLiQ interface. Note that temperature measurement and transmission are not secure in the sense of functional safety.

The temperature measured by the internal temperature sensor is higher by a device-specific and application-specific amount than the temperature at the measuring point M1 in accordance with the dimension drawing.

When the trigger threshold is exceeded for the internal temperature, the encoders issue the error message "Alarm 405." This threshold depends on the encoder model and is shown in the specifications. Keeping a sufficient distance from the error-message threshold is recommended during operation.

The encoder's intended use requires compliance with the operating temperature at the measuring point M1.

DRIVE-CLiQ is a registered trademark of SIEMENS AG.

Temperature measurement

Temperature measurement in motors

In order to protect a motor from an excessive load, the motor manufacturer usually installs a temperature sensor near the motor coil.

The PT 1000 or alternatively the semiconductor sensor KTY 84-130 is to be used. The following values for the accuracy of the evaluation circuit apply to the PT 1000:

± 4 K	at	80 °C	to	160 °C	
± 6 K	at	-40 °C	to	80 °C	
		and	160 °C	to	200 °C

The following values for the accuracy of the evaluation circuit apply to the KTY 84-130 semiconductor sensor:

± 2 K	at	80 °C	to	160 °C	
± 6 K	at	-40 °C	to	80 °C	
		and	160 °C	to	200 °C

The temperature values are transmitted via the DRIVE-CLiQ protocol.

The temperature sensor used is adjustable via parameter 601 in the configuration software (e.g., starter) of the drive.

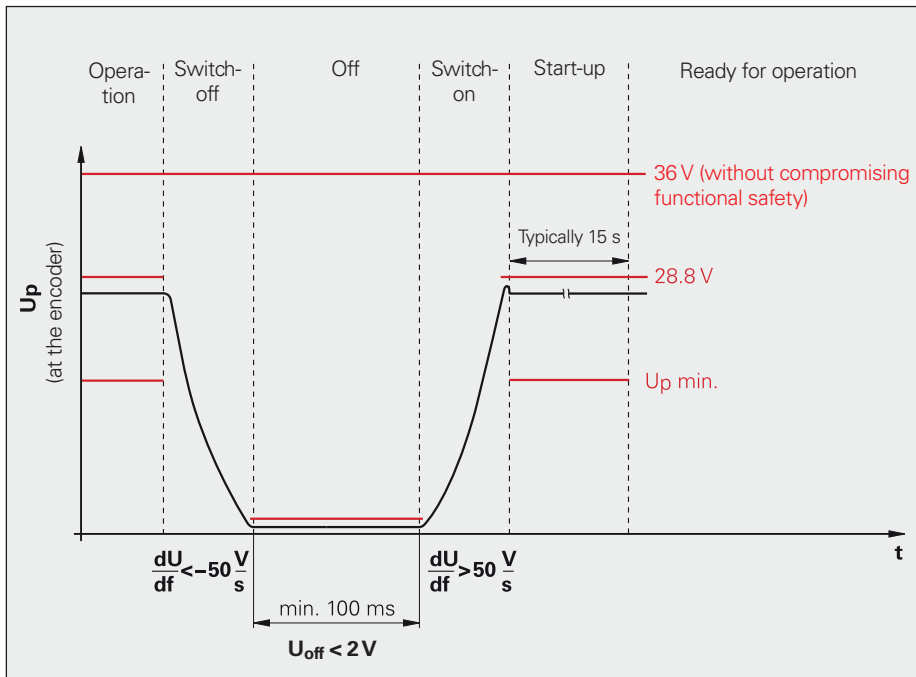

Electrical requirements

Switch-on and switch-off conditions







Electrical connection

Cables

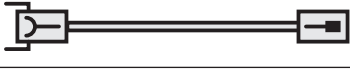
EPG cables inside the motor housing $\varnothing 3.7 \text{ mm}$; $[(2 \times 2 \times 0.06) + (4 \times 0.06)] \text{ mm}^2$		
Complete with PCB connector, 16-pin and SpeedTEC M23 right-angle socket (male), 9-pin; with wires for temperature sensor		ID 1120945-xx ¹⁾
Complete with PCB connector, 16-pin and M12 flange socket (male), 8-pin; with wires for temperature sensors		ID 1181373-xx ¹⁾

¹⁾ **Note for safety-related applications:** CE compliance of the complete system must be documented!











PUR connecting cable $\varnothing 6.8 \text{ m}$; $[(2 \times 2 \times 0.17 \text{ mm}^2) + (2 \times 0.24 \text{ mm}^2)]$; $A_P = 0.24 \text{ mm}^2$		
Complete with SpeedTEC M23 connector (female) and RJ45 Siemens connector (IP20)		ID 1121546-xx
Complete with SpeedTEC M23 connector (female) and coupling M12 (male), 8-pin		ID 1121536-xx
Complete with M12 connector (female) and M12 coupling (male), 8-pin		ID 822504-xx
Complete with M12 connector (female), 8-pin, and RJ45 Siemens connector (IP67)		ID 1094652-xx
Complete with M12 connector (female), 8-pin, and RJ45 Siemens connector (IP20)		ID 1093042xx

A_P : Cross section of power supply lines

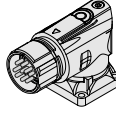
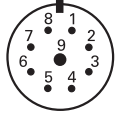
SpeedTEC is a registered trademark of TE Connectivity Industrial GmbH.

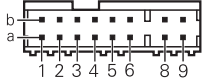
Electrical connection

Pin layout

M12 flange socket, 8-pin   					M23 SpeedTEC angle flange socket, 9-pin   					
PCB connector, 16-pin  16 										
	Power supply				Serial data transfer				Other signals ¹⁾	
 M12	8	2	1	5	3	4	7	6	/	/
 M23	3	7	8	4	5	6	1	2	/	/
 16	1b	6a	3a	4b	6b	1a	2b	5a	8a	8b
	–	–	Up	0V	RXP	RXN	TXP	TXN	T+ ²⁾	T– ²⁾
	Brown/ Green	Blue	White	White/ Green	Gray	Pink	Violet	Yellow	Brown	Green

Cable shield connected to housing; **Up** = voltage supply
 Vacant pins or wires must not be used!

Encoder cables with a cable length > 0.5 m require strain relief of the cable

¹⁾ Only for output cables inside the motor housing

²⁾ Connections for external temperature sensor, evaluation optimized for KTY 84-130/PT 1000 (see *Temperature measurement in motors* in the brochure *Position Encoders for Servo Drives*)

SpeedTEC is a registered trademark of TE Connectivity Industrial GmbH.

HEIDENHAIN

DR. JOHANNES HEIDENHAIN GmbH

Dr.-Johannes-Heidenhain-Straße 5

83301 Traunreut, Germany

☎ +49 8669 31-0

☎ +49 8669 32-5061

E-mail: info@heidenhain.de

www.heidenhain.de

This Product Information supersedes all previous editions, which thereby become invalid. The basis for ordering from HEIDENHAIN is always the Product Information document edition valid when the order is made.



For more information:

Comply with the requirements described in the following documents to ensure the correct operation of the encoder:

- Brochure: *Position encoders for Servo Drives*: 208922
- *Interfaces of HEIDENHAIN Encoders* brochure: 1078628
- Mounting Instructions: *ECN 1324S, EQN 1336S*: 1038275
- Technical Information: *Safety-Related Position Measuring Systems*: 596632
- Brochure: *Cables and Connectors*: 1206103