



Product Information

Gateway

For Connecting
EnDat Encoders
to PROFIBUS DP

PROFIBUS gateway

For connecting EnDat encoders

Encoders with EnDat interface for connection via gateway

All absolute encoders from HEIDENHAIN with **EnDat interface** are suitable for PROFIBUS DP. The encoders are electrically connected through a **gateway**. The complete interface electronics are integrated in the gateway, as well as a voltage converter for supplying EnDat encoders with DC 5 V $\pm 5\%$. This offers a number of benefits:

- Simple connection of the fieldbus cables, since the terminals are easily accessible
- Encoder dimensions remain small
- No temperature restrictions for the encoder. All temperature-sensitive components are in the gateway
- No bus interruption when an encoder is exchanged

Besides the EnDat encoder connector, the gateway provides connections for the PROFIBUS and the power supply. In the gateway there are coding switches for addressing and selecting the terminating resistor.

Since the gateway is connected as a bus member, the connecting cable to the encoder does not act as a stub line although it can be up to 40 meters long.

PROFIBUS DP

PROFIBUS is a non-proprietary, open fieldbus that complies with the international standard EN 50170. The connection of sensors through fieldbus systems minimizes cabling and reduces the number of lines between the encoder and the subsequent electronics.

PROFIBUS DP profile

The PNO (PROFIBUS user organization) has defined a standardized, non-proprietary profile for the connection of absolute encoders to the PROFIBUS DP fieldbus. This ensures high flexibility and easy configuration on all systems that use this standardized profile.

Commissioning

The general station description (GSD) files completely and clearly describe the characteristics of the gateway in a precisely defined format. The GSD file can be downloaded from the HEIDENHAIN Filebase.

DP-V0 profile

This profile can be requested from the PNO in Karlsruhe, Germany (ordering number: 3.062). There are two classes defined in this profile: Class 1 is equivalent to the minimum range of functions, and Class 2 contains additional functions, some of which are optional.

DP-V1 and DP-V2 profiles

The profiles can be requested from the PNO in Karlsruhe, Germany (ordering number: 3.162). These profiles likewise distinguish between two device classes:

- Class 3 with the basic functions, and
- Class 4 with the full scaling and preset functionality.

In addition to the mandatory functions of Classes 3 and 4, optional functions are defined as well.

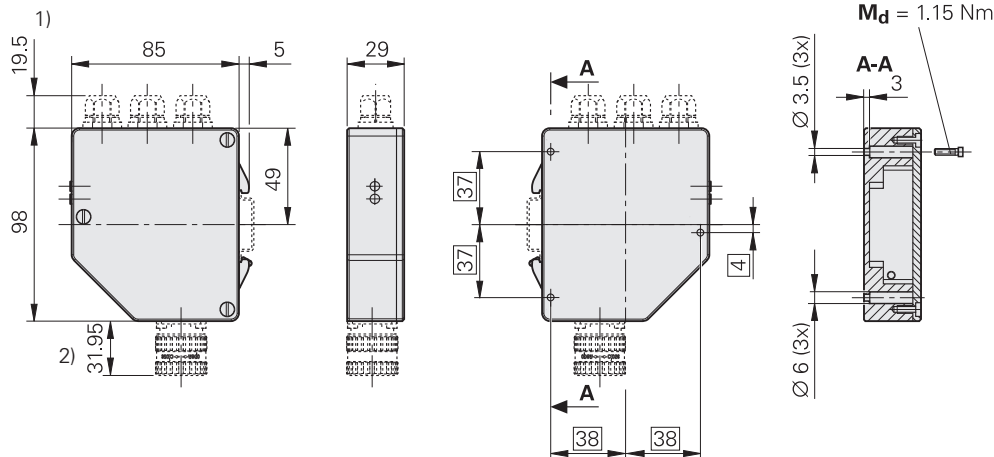

mm

 Tolerancing ISO 8015
 ISO 2768 - m H
 $\leq 6 \text{ mm}: \pm 0.2 \text{ mm}$

1) Maximum values depending on version (cable gland or M12)
 2) Maximum values depending on version (M12 or M23)

Specifications	PROFIBUS DP gateway
Input	For absolute linear, angle, and rotary encoders with the ordering designation EnDat22—except LC xx3 (multiturn rotary encoders with buffer battery backup are not supported)
Connection*	8-pin M12 flange socket (female) 17-pin M23 flange socket (female)
Cable length	≤ 40 m (with HEIDENHAIN cable), greater lengths upon request
Power supply (encoder)	DC 5 V ±5 % (max. 400 mA)
EnDat clock frequency	500 kHz
Output	PROFIBUS DP-V0, Classes 1 and 2 PROFIBUS DP-V1, DP-V2, Classes 3 and 4 Integrated T-junction and bus termination (can be switched off)
Operating status displays	Integrated LED displays: <ul style="list-style-type: none"> • “Module” ≙ Gateway status • “Bus” ≙ PROFIBUS status
PROFIBUS clock frequency	9.6 kbit/s to 12 Mbit/s
Bus connection* (BUS in, BUS out, power supply)	Three 4-pin or 5-pin M12 Speedcon connecting elements Three M16 ²⁾ cable glands (terminal block inside the device)
Address setting range	0 to 126 (selectable by switch)
Cable length	≤ 400 m at 1.5 Mbit/s ≤ 100 m at 12 Mbit/s
Supply voltage	DC 9 V to 36 V
Power consumption	Maximum: 9 V: ≤ 4.8 W; 36 V: ≤ 4.8 W (residual ripple included) Typical: 1.5 W + P _{encoder} × 1.33
Operating temperature	−40 °C to +80 °C
Vibration 50 Hz to 2000 Hz Shock 11 ms	≤ 100 m/s ² (EN 60068-2-6) ≤ 300 m/s ² (EN 60068-2-27)
Protection EN 60529	IP65
Mass	Approx. 400 g
Dimensions	Approx. 150 mm x 90 mm x 30 mm
Fastening	Top-hat rail mounting

* Please select when ordering

¹⁾ EnDat encoders with the ordering designations EnDat01 or EnDat02 (except LC xx3) can also be connected. However, the information available via PROFIBUS is generated on the basis of the EnDat2.1 instruction set. The position value corresponds to the absolute value transmitted over the EnDat interface without interpolation of the 1 V_{PP} signals.

²⁾ Only when used in conjunction with the M23 input connector

Supported functions

Of particular importance in decentralized fieldbus systems are **diagnostic functions** (e.g., warnings and alarms) and the **electronic ID label**, which contains information about the encoder model, resolution, and measuring range. Yet programming functions are possible as well, such as reversal of counting direction, **preset/datum shift**, and **changing the resolution (scaling)**. The operating time of the encoder can also be recorded.

DP-V0

Characteristic <i>Data word width</i>	Class	Rotational encoders		Linear encoders
		≤ 16 bits	≤ 31 bits ¹⁾	≤ 31 bits ¹⁾
Pos. value in pure binary code	1, 2	✓	✓	✓
Data word length	1, 2	16	32	32
Scaling function Measuring steps/rev. Total resolution	2 2	✓ ✓	✓ ✓	– –
Reversal of counting direction	1, 2	✓	✓	–
Preset (output data: 16 bits or 32 bits)	2	✓	✓	✓
Diagnostic functions Warnings and alarms	2	✓	✓	✓
Operating time recording	2	✓	✓	✓
Speed	2	✓ ²⁾	✓ ²⁾	–
Profile version	2	✓	✓	✓
Serial number	2	✓	✓	✓

¹⁾ With a data word width > 31 bits, only the upper 31 bits are transferred

²⁾ Requires a 32-bit configuration of the output data and a 32+16-bit configuration of the input data

DP-V1, DP-V2

Characteristic <i>Data word width</i>	Class	Rotational encoders		Linear encoders
		≤ 32 bits	> 32 bits	
Telegram	3, 4	81-84	84	81-84
Scaling function	4	✓	✓	–
Reversal of counting direction	4	✓	✓	–
Preset/ datum shift	4	✓	✓	✓
Acyclic parameters	3, 4	✓	✓	✓
Channel-dependent diagnosis via alarm channel	3, 4	✓	✓	✓
Operating time recording	3, 4	✓ ¹⁾	✓ ¹⁾	✓ ¹⁾
Speed	3, 4	✓ ¹⁾	✓ ¹⁾	–
Profile version	3, 4	✓	✓	✓
Serial number	3, 4	✓	✓	✓

¹⁾ Not supported by DP-V2

Electrical connection

PROFIBUS DP

M16 cable gland

In the versions with M16 cable gland, the bus lines and the power supply line are applied to a terminal block.

Connecting terminals			
Power supply		Absolute position values BUS in or BUS out	
+E	0V	A	B
U_P	0V	DATA (A)	DATA (B)

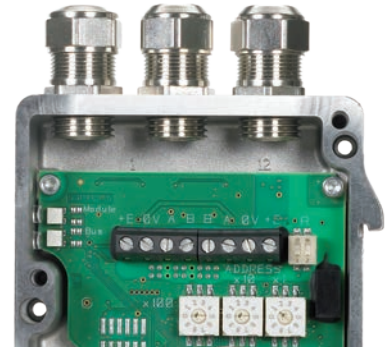

M12 flange socket

PROFIBUS DP and the power supply are connected via the M12 connecting elements. The following mating connectors are required:

Bus input:

5-pin B-coded M12 connector (female)

Bus output:

5-pin B-coded M12 coupling (male)

Power supply:

4-pin A-coded M12 connector

Accessory:

4-pin B-coded M12 **adapter connector** (male)

Suitable for 5-pin bus output, with PROFIBUS terminating resistor.

Required for last bus member if the encoder's internal terminating resistor is not to be used.

ID 584217-01

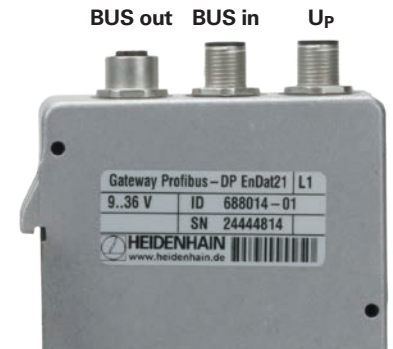

Mating connector: Bus input 5-pin M12 connector (female) B-coded					Mating connector: Bus output 5-pin M12 coupling (male) B-coded	
	Power supply				Absolute position values	
	1	3	5	Housing	2	4
BUS in	/	/	Shield	Shield	DATA (A)	DATA (B)
BUS out	U¹⁾	0V¹⁾	Shield	Shield	DATA (A)	DATA (B)



¹⁾ For supplying an external terminating resistor

Mating connector: Power supply 4-pin M12 connector (female) A-coded				
	1	3	2	4
	U_P	0V	Vacant	Vacant

Encoders with EnDat interface

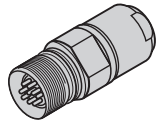
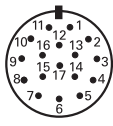
Mating connector:
17-pin M23 coupling

	Power supply					Incremental signals ¹⁾				Absolute position values			
	7	1	10	4	11	15	16	12	13	14	17	8	9
	U_P	Sensor U _P	0V	Sensor 0V	Internal shield	A+	A-	B+	B-	DATA	DATA	CLOCK	CLOCK
	Brown/ Green	Blue	White/ Green	White	/	Green/ Black	Yellow/ Black	Blue/ Black	Red/ Black	Gray	Pink	Violet	Yellow

Cable shield connected to housing; **U_P** = Power supply voltage



Sensor: The sense line is connected in the encoder with the corresponding power supply line.

Vacant pins or wires must not be used.

¹⁾ Only with ordering designations EnDat 01 and EnDat 02; not evaluated by the gateway

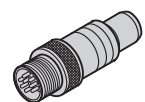
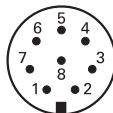
Mating connector:
8-pin M12 coupling

	Power supply					Absolute position values			
	8	2	5	1	3	4	7	6	
	U_P	U_P ¹⁾	0V	0V ¹⁾	DATA	DATA	CLOCK	CLOCK	
	Brown/Green	Blue	White/Green	White	Gray	Pink	Violet	Yellow	

Cable shield connected to housing; **U_P** = Power supply voltage

Vacant pins or wires must not be used.

¹⁾ The parallel voltage supply line is connected in the encoder with the corresponding power supply line.

HEIDENHAIN

DR. JOHANNES HEIDENHAIN GmbH

Dr.-Johannes-Heidenhain-Straße 5

83301 Traunreut, Germany

☎ +49 8669 31-0

☎ +49 8669 32-5061

E-mail: info@heidenhain.de

www.heidenhain.de

This Product Information document supersedes all previous editions, which thereby become invalid. The basis for ordering from HEIDENHAIN is always the Product Information document edition valid when the order is made.



Further information:

Comply with the requirements described in the following documents to ensure correct and intended operation:

- Brochure: *Rotary Encoders* 349529-xx
- Brochure: *Encoders for Servo Drives* 208922-xx
- Brochure: *Angle Encoders with Integral Bearing* 951109-xx
- Brochure: *Linear Encoders for Numerically Controlled Machine Tools* 571470-xx
- Brochure: *Cables and Connectors* 1206103-xx